

## Operating manual

Flow measurement cell

Heavy-Duty Line

**TMM50 Heavy-Duty**

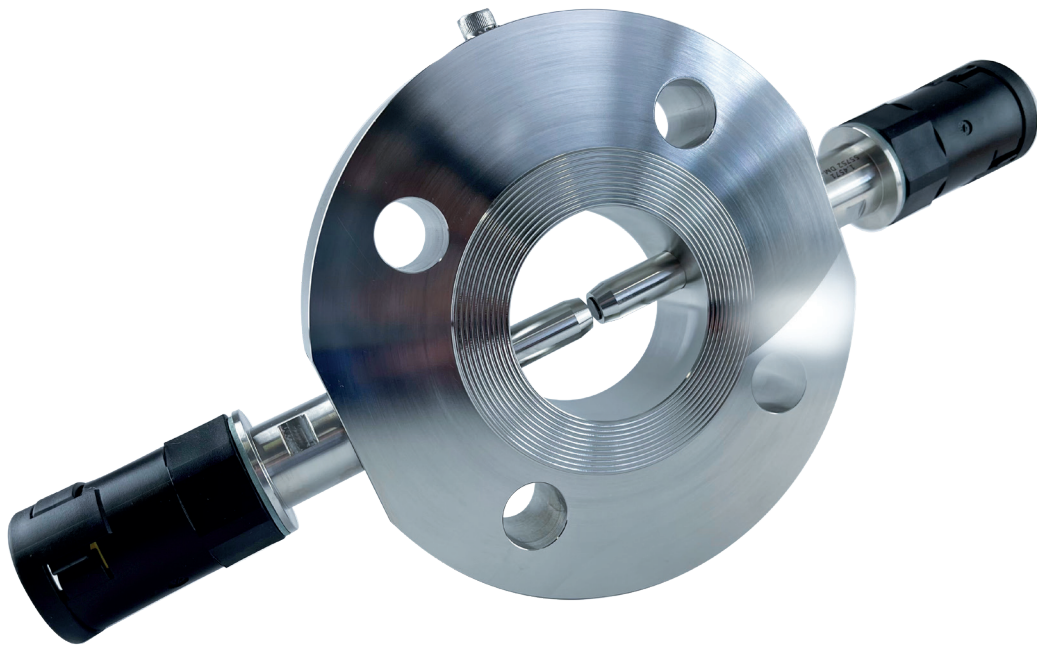

## Translation of original operating manual

### **PLS-TEC**

PLS Prozess- Labor- und Sensortechnik GmbH  
Mittelstraße 23  
07745 Jena  
Germany

Phone +49 3641 – 47 92 80  
Fax +49 3641 – 47 92 81  
[info@pls-tec.com](mailto:info@pls-tec.com)  
[www.pls-tec.com](http://www.pls-tec.com)

## Table of contents

|          |                                                                |           |
|----------|----------------------------------------------------------------|-----------|
| <b>1</b> | <b>About the document .....</b>                                | <b>5</b>  |
| 1.1      | Purpose and content of the operating manual .....              | 5         |
| 1.2      | Reading and storing the operating manual .....                 | 5         |
| 1.3      | Non-observance of the operating manual.....                    | 5         |
| 1.4      | Symbols and illustrations used in the operating manual.....    | 6         |
| 1.4.1    | Warnings and notices.....                                      | 6         |
| <b>2</b> | <b>Safety.....</b>                                             | <b>7</b>  |
| 2.1      | Intended use.....                                              | 7         |
| 2.2      | Use in hazardous areas.....                                    | 8         |
| 2.3      | Modifications and conversions.....                             | 8         |
| 2.4      | Personnel – activities and qualifications.....                 | 8         |
| 2.5      | Personal protective equipment .....                            | 9         |
| 2.6      | For your safety.....                                           | 9         |
| <b>3</b> | <b>Set-up and function .....</b>                               | <b>10</b> |
| 3.1      | Set-up .....                                                   | 10        |
| 3.2      | Function.....                                                  | 11        |
| <b>4</b> | <b>Goods receipt, unpacking, transport and storage.....</b>    | <b>12</b> |
| 4.1      | Goods receipt .....                                            | 12        |
| 4.2      | Unpacking and transport.....                                   | 12        |
| 4.3      | Storage .....                                                  | 13        |
| <b>5</b> | <b>Scope of delivery and identification .....</b>              | <b>13</b> |
| 5.1      | Scope of delivery .....                                        | 13        |
| 5.2      | Identification .....                                           | 13        |
| <b>6</b> | <b>Assembly.....</b>                                           | <b>14</b> |
| 6.1      | Assembling the flow measurement cell in a piping system.....   | 14        |
| 6.2      | Assembling collimators.....                                    | 14        |
| 6.3      | Notices on handling optical fibers .....                       | 16        |
| 6.4      | Connecting the spectrometer to the flow measurement cell ..... | 16        |
| 6.5      | Connecting the customer grounding.....                         | 17        |
| 6.6      | Connecting the customer flushing.....                          | 17        |
| 6.7      | Assembling the customer temperature sensor .....               | 17        |
| <b>7</b> | <b>Commissioning and operation .....</b>                       | <b>17</b> |

**Table of contents**

---

- 7.1 Required tests before commissioning ..... 17
- 7.2 Operation ..... 17
- 8 Cleaning and maintenance ..... 18**
  - 8.1 Cleaning..... 18
  - 8.2 Maintenance ..... 18
- 9 Customer service ..... 19**
- 10 Spare parts and repair ..... 19**
- 11 Return ..... 19**
- 12 Decommissioning, disassembly and disposal ..... 20**
  - 12.1 Decommissioning the measurement cell ..... 20
  - 12.2 Disassembling the flow measurement cell from the piping system .... 20
  - 12.3 Disposal ..... 20
- Index..... 21**

# **1 About the document**

## **1.1 Purpose and content of the operating manual**

This operating manual provides all the information required for the product in the various phases of its life cycle.

This operating manual contains information on the following: set-up and function, transport and storage, assembly, commissioning, cleaning and maintenance, return, decommissioning, disassembly and disposal.

## **1.2 Reading and storing the operating manual**

The requirement for safe work is compliance with all specified safety notes, warnings and instructions. In addition, the local accident prevention regulations, general safety regulations and local environmental regulations applicable to the operating area of the product must be observed.

Read this operating manual carefully before starting any work! The operating manual is an integral part of the product and must be kept in the immediate vicinity of the product and accessible to personnel at all times.

If the product is passed on to third parties, also pass on this operating manual.

## **1.3 Non-observance of the operating manual**

PLS-TEC accepts no liability for personal injury or property damage caused by failure to observe the operating manual.

This applies in particular to damage caused by:

- improper use
- assignment of unqualified personnel
- use of unauthorised components
- unauthorised modifications
- improper assembly
- poorly or not performed maintenance and repairs
- use of unauthorised spare parts
- operation of a defective product



## 1.4 Symbols and illustrations used in the operating manual



### 1.4.1 Warnings and notices



In this manual, warnings are labelled with symbols. A warning is introduced by a signal word that expresses the extent of the hazard.

Always observe the warnings and act with caution to avoid accidents, personal injury and property damage.

#### Warnings

|  <b>DANGER</b> |                                                                                                                                          |
|-------------------------------------------------------------------------------------------------|------------------------------------------------------------------------------------------------------------------------------------------|
|                | The signal word <b>DANGER</b> indicates an imminently hazardous situation which, if not avoided, will result in death or serious injury. |

|  <b>WARNING</b> |                                                                                                                                          |
|--------------------------------------------------------------------------------------------------|------------------------------------------------------------------------------------------------------------------------------------------|
|                | The signal word <b>WARNING</b> indicates a potentially hazardous situation which, if not avoided, may result in death or serious injury. |

|  <b>CAUTION</b> |                                                                                                                               |
|----------------------------------------------------------------------------------------------------|-------------------------------------------------------------------------------------------------------------------------------|
|                 | The signal word <b>CAUTION</b> indicates a potentially hazardous situation which, if not avoided, may result in minor injury. |

| <b>NOTICE</b>                                                                       |                                                                                                                                |
|-------------------------------------------------------------------------------------|--------------------------------------------------------------------------------------------------------------------------------|
|  | The signal word <b>DANGER</b> indicates a potentially harmful situation which, if not avoided, will result in property damage. |

#### Tips and recommendations

---

|                                                                                     |                                                                                                                                                            |
|-------------------------------------------------------------------------------------|------------------------------------------------------------------------------------------------------------------------------------------------------------|
|  | <b>IMPORTANT!</b><br>The word <b>IMPORTANT</b> highlights useful tips and recommendations as well as information for efficient and trouble-free operation. |
|-------------------------------------------------------------------------------------|------------------------------------------------------------------------------------------------------------------------------------------------------------|

---

## 2 Safety

### 2.1 Intended use

The flow measurement cell TMM50 Heavy-Duty is a transmission measurement cell and is intended for fiber-optic process coupling to a spectrometer.

The flow measurement cell is installed in a process line or in a bypass and is suitable for liquid and gaseous process media.

The flow measurement cell may only be operated within the permissible operating limits. Operating limits: [↗ Order-specific data and documents: Specification sheet](#)

The flow measurement cell may only be used for process media for which the materials used are suitable. Materials used: [↗ Order-specific data and documents: Specification sheet](#)

The collimators and optical fibers supplied must be suitable for the area of application. As standard, the optical fibers supplied are solarisation sensitive and **not** suitable for UV radiation (< 220 nm). The optical fiber must be solarisation resistant to UV radiation. [↗ Order-specific data and documents: Specification sheet](#)

By default, the optical fibers supplied are **not** suitable for pulsed lasers or high-performance lasers. When using the flow measurement cell with a pulsed laser or high-performance laser, consult PLS-TEC.

The flow measurement cell fulfils the requirements of the Pressure Equipment Directive 2014/68/EU.

The flow measurement cell was developed for installation in a superordinate system. The new risks arising from the installation must be assessed by the operator of the overall system and must be taken into account accordingly in the system documentation.

#### Misuse

Any use other than or beyond this is considered improper use. PLS-TEC is not liable for any resulting personal injury or property damage.

## 2.2 Use in hazardous areas

The flow measurement cells of the type TMM50 Heavy-Duty are only to be regarded as viewing windows according to DIN IEC EN 60079. These flow measurement cells can therefore be installed and used in all EX zones.

All materials used in these flow measurement cells comply with the DIN IEC EN 60079-0 standard. For details of the materials used, please see the material certificates supplied (EN 10204).

When using the flow measurement cells TMM50 Heavy-Duty, the operator must ensure that the optical radiation power introduced by them, e.g. by a spectrometer, remains within the limits specified by the standard DIN IEC EN 60079-28.

General information:

- When installing flow measurement cells in hazardous areas / EX zones, the operator must observe all regional guidelines and regulations.
- The flow measurement cells must be grounded. Use the grounding connection on the flow measurement cell for this purpose.

## 2.3 Modifications and conversions

Modifications and conversions to the product, an accessory or one of the components may result in unforeseen dangers.

Written authorisation must be obtained from PLS-TEC before performing any technical modifications and conversions on the product or any of its components.

## 2.4 Personnel – activities and qualifications

Only qualified specialist personnel authorised by the operator may perform work on and with the product. The specialist personnel must know and understand the operating manual and the necessary operating instructions.

The specialist personnel working on and with the product must fulfil the following requirements:

- Has completed training as a plant mechanic, plant fitter, assembly mechanic, assembly fitter or has comparable technical training.
- Has additional knowledge and experience.
- Knows the respective technical terms and regulations.
- Can assess the work assigned to them, recognise potential hazards and take appropriate safety measures.



## 2.5 Personal protective equipment

No specific personal protective equipment is required for handling the flow measurement cell.

However, it may be necessary to wear personal protective equipment due to the risk assessment at the place of use of the flow measurement cell.

## 2.6 For your safety

---



### **Risk of bursting due to unauthorised operating conditions!**

If the flow measurement cell is operated under impermissible operating conditions, the flow measurement cell may burst and cause serious injury.

- › Only operate the flow measurement cell under permissible operating conditions.
  - › Avoid pressures surges.
  - › Avoid sudden temperature fluctuations.
- 



### **Leaking process medium!**

If process medium escapes from the flow measurement cell, this may result in environmental damage, property damage and serious injury, depending on the process medium.

- › Before commissioning the flow measurement cell, check the flow measurement cell for tightness.
  - › If process medium escapes, decommission the flow measurement cell immediately.
- 



### **Damaged flow measurement cell!**

If the flow measurement cell is damaged, process medium can escape and cause environmental damage, property damage and serious injury.

- › Decommission the damaged flow measurement cell immediately.
- › Return the damaged flow measurement cell to PLS-TEC.

[↗ Page 19, chapter 11](#)

---

### 3 Set-up and function

#### 3.1 Set-up

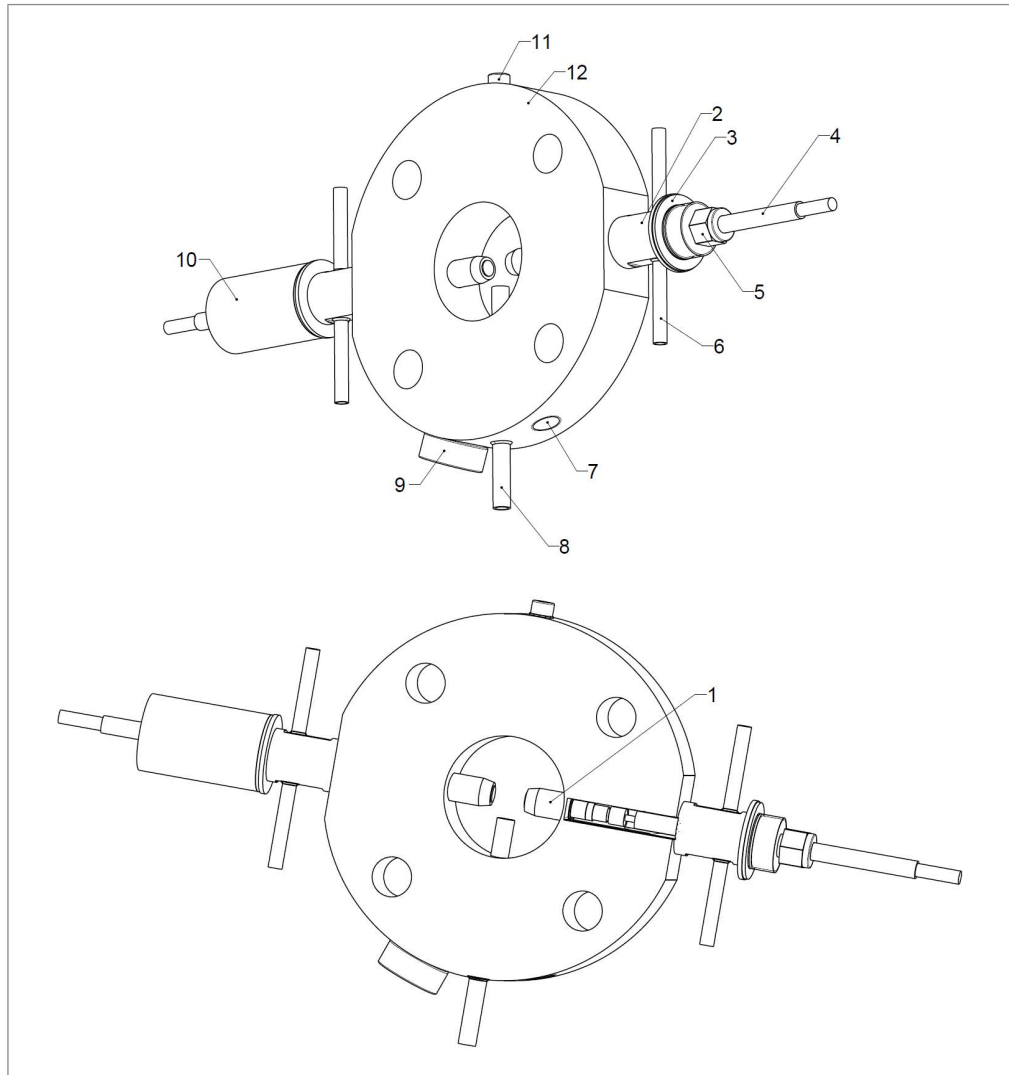

Fig. 1: Set-up of flow measurement cell TMM50 Heavy-Duty

- 1 Collimator with lens
- 2 Protective adapter connection
- 3 Flat gasket
- 4 Optical fiber
- 5 Screw connection
- 6 Flushing connection for optical holder (special version)
- 7 Thread for customer temperature sensor (special version)
- 8 Flushing connection for optical path (special version)
- 9 RFID tag (special version)
- 10 Protective adapter
- 11 Grounding connection
- 12 Flange

## 3.2 Function

The flow measurement cell TMM50 Heavy-Duty is a transmission measurement cell and is assembled either directly into a process line or in a bypass. The flow measurement cell is connected to a spectrometer via two optical fibers. This allows the flow cell to be used for continuous analysis.

The signal sent by the spectrometer is transmitted via an optical fiber and a collimator with lens into the flow measurement cell and through the process medium to the opposite collimator. From this collimator, the signal returns to the spectrometer.

## 4 Goods receipt, unpacking, transport and storage

### 4.1 Goods receipt

Check the delivery immediately upon receipt for completeness and transport damage.

In case of externally recognisable transport damage, proceed as follows:

- Do not accept delivery or only accept delivery with reservations.
- Note the extent of the damage on the transport documents or on the carrier's delivery note.
- Initiate complaint.



#### IMPORTANT!

Complain about any defect as soon as it is recognised. Claims for damages can only be asserted within the applicable complaint periods.

---

### 4.2 Unpacking and transport

1. Check the scope of delivery against the delivery note.
2. Report incomplete and incorrect delivery to PLS-TEC.
3. Separate the packaging according to type and size and dispose of for further use or recycling. Observe national and regional laws and guidelines.

#### Flow measurement cell

The flow measurement cell is supplied in a transport case.

Always transport the flow measurement cell in the transport case.

#### Collimators

The collimators are supplied either in the transport case or separately in a package.

Only unpack the collimators prior to assembly at the assembly site. If the flow measurement cell is disassembled, disassemble the collimators before removing the flow measurement cell. Never transport collimators assembled in the flow measurement cell.

#### Optical fiber

Optical fibers longer than 5 m are supplied on a cable reel.

- Store optical fibers on the cable reel.
- Only unroll the optical fiber for installation.

Only return optical fibers after consultation with PLS-TEC.

### 4.3 Storage

For storage, observe the following:

- Always store the flow measurement cell in the transport case.
- Store collimators protected from mechanical damage.
- Always store optical fibers supplied on a cable reel on the cable reel.
- Do not store outdoors.
- Store in a dry and dust-free place.
- Store at room temperature.
- Protect from sunlight.
- If stored for longer than 3 months, regularly check the general condition of all components.

## 5 Scope of delivery and identification

### 5.1 Scope of delivery

For the version, options and accessories, see the specification sheet.

➤ [Order-specific data and documents: Specification sheet](#)

### 5.2 Identification

The following information is lasered on the outside of the flange: Logo, Type, serial number, nominal diameter, pressure rating and CE mark.





Fig. 2: Example: Information on the outside of the flange

- 1 Logo
- 2 Type
- 3 Serial number
- 4 Nominal diameter, pressure rating
- 5 CE mark

A serial number is printed on every optical fiber that is connected to a collimator. The information on the outside of the flange and the serial numbers for the optical fibers are given in the specification sheet. ➤ [Order-specific data and documents: Specification sheet](#)

## 6 Assembly

### 6.1 Assembling the flow measurement cell in a piping system

|  <b>WARNING</b> |                                                                                                                                                                                                                                                                                                                                                                                                                                                      |
|--------------------------------------------------------------------------------------------------|------------------------------------------------------------------------------------------------------------------------------------------------------------------------------------------------------------------------------------------------------------------------------------------------------------------------------------------------------------------------------------------------------------------------------------------------------|
|                 | <p><b>Risk of bursting due to unauthorised operating conditions!</b></p> <p>If the flow measurement cell is operated under impermissible operating conditions, the flow measurement cell may burst and cause serious injury.</p> <ul style="list-style-type: none"><li>› Only operate the flow measurement cell under permissible operating conditions.</li><li>› Avoid pressures surges.</li><li>› Avoid sudden temperature fluctuations.</li></ul> |

#### Requirements

- Collimators not assembled

The flow measurement cell can be assembled either directly into a process line or in a bypass. As long as the flow measurement cell is operated under the permissible operating conditions and pressure surges and sudden temperature fluctuations are avoided, PLS-TEC has no further specifications for the assembly of the flow measurement cell.

The system operator and/or the company commissioned by the system operator for planning and assembly are responsible for the proper and safe assembly of the flow measurement cell.

### 6.2 Assembling collimators

| <b>NOTICE</b>                                                                       |                                                                                                                                                                                                                                                                                                                                 |
|-------------------------------------------------------------------------------------|---------------------------------------------------------------------------------------------------------------------------------------------------------------------------------------------------------------------------------------------------------------------------------------------------------------------------------|
|  | <p><b>Improper handling of optical fibers!</b></p> <p>Damage to the optical fiber possible.</p> <ul style="list-style-type: none"><li>› Do not bend the optical fiber below a minimum bending radius of 40 cm.</li><li>› Observe chapter „Notices on handling optical fibers“: <a href="#">↗ Page 16, chapter 6.3</a></li></ul> |

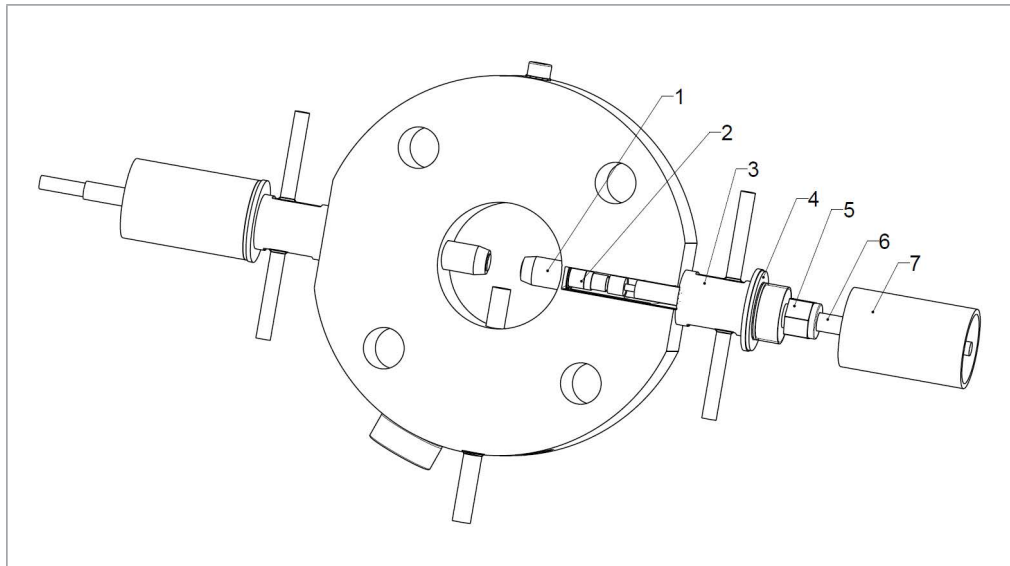

Fig. 3: Assembling the collimator

- 1 Optical holder
- 2 Collimator
- 3 Protective adapter connection
- 4 Protective adapter flat gasket
- 5 Screw connection
- 6 Optical fiber
- 7 Protective adapter

Proceed as follows for each collimator:

1. Unscrew the protective adapter (7).
2. Unscrew the screw connection (5).
3. Remove the flat gasket (4).
4. Push the collimator (2) with the optical fiber (6) through the protective adapter connection (3) into the optical holder (1) as far as it will go.
5. Slide the screw connection (5) over the optical fiber and tighten with an open-end spanner until the optical fiber is secured against slipping.
6. Carefully slide the protective adapter over the optical fiber (6).
7. Place the flat gasket (4).
8. Slide the protective adapter (7) over the protective adapter connection (3) and screw tight.

### 6.3 Notices on handling optical fibers

The optical fibers are made of quartz glass. The fibers are rather stiff and can break. The fibers are protected against external influences with a flexible protective tube (mono-coil).

The following points must be observed to ensure that the optical fibers function properly:

- If the optical fiber was supplied on a cable reel, first unroll the optical fiber for installation.
- Check the optical fibers supplied for the area of application. As standard, the optical fibers supplied are solarisation sensitive and **not** suitable for UV radiation (< 220 nm). The optical fiber must be solarisation resistant to UV radiation. [↗ Order-specific data and documents: Specification sheet](#)
- Do not bend the optical fiber below a minimum bending radius of 40 cm.
- Do not exceed the maximum permissible temperature of the optical fiber. [↗ Order-specific data and documents: Specification sheet](#)
- Do not lay optical fibers across sharp corners and edges.
- Do not crush optical fibers.
- Do not lay optical fibers on the ground if the optical fiber could be driven over or stepped on.
- Do not strain or compress optical fibers. Install the optical fibers strain-free.
- Only pull the optical fibers by the sleeve. Never pull on the optical fiber.
- The ends of the optical fibers are protected either by a collimator or a protective cap. Do not remove the protective cap until immediately before connecting to the spectrometer. Protect open optical fiber ends, e.g. with a protective cap.
- Do not expose optical fibers to chemical media.

### 6.4 Connecting the spectrometer to the flow measurement cell

Connect the flow measurement cell according to the spectrometer documentation.



## 6.5 Connecting the customer grounding

The flow measurement cell is supplied with an assembled tooth washer and screw for customer grounding. Grounding: [↗ Page 10, Fig. 1](#)

## 6.6 Connecting the customer flushing

The flow measurement cell is optionally equipped with connections for connecting the customer flushing. Flushing connection: [↗ Page 10, Fig. 1](#)

Contaminated flushing media can falsify the measurement result. Highly purified compressed air or nitrogen is usually used as the flushing medium.

## 6.7 Assembling the customer temperature sensor

The flow measurement cell is optionally equipped with a thread for assembling the customer temperature sensor. Thread for temperature sensor: [↗ Page 10, Fig. 1](#)

# 7 Commissioning and operation

## 7.1 Required tests before commissioning

The flow measurement cell fulfils the requirements of the Pressure Equipment Directive 2014/68/EU.

Test after installing the flow measurement cell according to the system operator's specifications. The applicable regulations and technical rules must be complied with.

## 7.2 Operation

The flow measurement cell does not offer any operating options. It is operated via the spectrometer. Operate the spectrometer according to the spectrometer documentation.

## 8 Cleaning and maintenance

### 8.1 Cleaning

Clean according to the system operator's specifications. Observe the following notice "Improper cleaning".

| NOTICE                                                                            |                                                                                                                                                                                                                                                                                                                                                                                                                               |
|-----------------------------------------------------------------------------------|-------------------------------------------------------------------------------------------------------------------------------------------------------------------------------------------------------------------------------------------------------------------------------------------------------------------------------------------------------------------------------------------------------------------------------|
|  | <p><b>Improper cleaning!</b></p> <p>Improper cleaning of the flow measurement cell may result in damage to the flow measurement cell.</p> <ul style="list-style-type: none"> <li>› Clean within the permissible operating limits.</li> <li>› If cleaning agents are used, make sure that the materials used, such as seals/gaskets etc., are resistant to the ingredients.</li> <li>› Do not clean optical fibers.</li> </ul> |

### 8.2 Maintenance

The maintenance interval generally depends on local conditions such as ambient conditions, operating conditions and process medium and may deviate from the specified maintenance intervals.

Additional maintenance work may be required based on the use of the flow measurement cell. Comply with applicable regulations and technical rules.

| Typical interval | Works                                                                                                                                                                                                                                                                    | To be carried out by                                                      |
|------------------|--------------------------------------------------------------------------------------------------------------------------------------------------------------------------------------------------------------------------------------------------------------------------|---------------------------------------------------------------------------|
| Every 6 months   | External tests: <ul style="list-style-type: none"> <li>• Visual inspections of the flow measurement cell.</li> <li>• Visual inspection of the surrounding flanges, seals/gaskets and screw connections.</li> <li>• Check the screw connections for tight fit.</li> </ul> | Specialist personnel according to Chapter 2.4<br><a href="#">↗ Page 8</a> |

Table 1: Maintenance schedule

## 9 Customer service

Our customer service is available for technical inquiries. Information about the responsible contact person can be obtained at any time by telephone, fax, e-mail or via the internet, see manufacturer's address on page 2.



### IMPORTANT!

For quick processing, note the type and serial number of the flow measurement cell before calling. [↗ Page 13, chapter 5.2](#)

## 10 Spare parts and repair

Spare parts: [↗ Order-specific data and documents](#)

The spare parts listed in the specification sheet may be replaced. All other components, such as the optical holder, must not be replaced.

### WARNING



#### Incorrect spare parts!

Incorrect spare parts may result in damage and/or malfunctions and injuries.

› Only use original spare parts or spare parts authorised by PLS-TEC.

## 11 Return

The requirements for a safe return may vary depending on the device or component and country-specific legislation.

Consult PLS-TEC before sending the device or component in for repair or inspection.

Returned devices or components will only be accepted by PLS-TEC if the following conditions are met:

- Device or component is completely cleaned and free of process medium.
- Fully completed and signed contamination sheet is enclosed.

Enclose the following additional information with the return:

- Data sheet of the process medium
- Description of the error that has occurred
- Special instructions, if applicable.

## 12 Decommissioning, disassembly and disposal

### 12.1 Decommissioning the measurement cell

#### Requirements

- Respective area of the piping system is depressurised
- Respective area of the piping system is empty, no flow

1. Switch off the spectrometer according to the spectrometer documentation.
2. If present, switch off the flushing device.
3. Disconnect the flushing from the flow measurement cell.
4. Disconnect the optical fiber from the flow measurement cell.
5. Protect the ends of the optical fibers with protective caps, for example.

### 12.2 Disassembling the flow measurement cell from the piping system

#### Requirements

- The flow measurement cell is decommissioned. [↗ Page 20, chapter 12.1](#)
1. Remove the collimators from the flow measurement cell. For disassembly, follow the reverse order to assembly. [↗ Page 14, chapter 6.2](#)
  2. Disassemble the flow measurement cell from the piping system.
  3. Store the flow measurement cell, collimators and optical fibers properly. [↗ Page 13, chapter 4.3](#)

### 12.3 Disposal

Recycle individual parts according to type and materials. Dispose of non-recyclable materials in an environmentally friendly manner. Observe local and national laws and guidelines.

## Index

### A

|                             |    |
|-----------------------------|----|
| Activities .....            | 8  |
| Assembly .....              | 14 |
| Collimators .....           | 14 |
| Flow measurement cell ..... | 14 |
| Temperature sensor .....    | 17 |

### C

|                               |        |
|-------------------------------|--------|
| Changes .....                 | 8      |
| Cleaning .....                | 18     |
| Collimator .....              | 10     |
| Collimators                   |        |
| Assembly .....                | 14     |
| Commissioning .....           | 17     |
| Connection                    |        |
| Flushing .....                | 17     |
| Grounding .....               | 10, 17 |
| Optical holder flushing ..... | 10     |
| Optical path flushing .....   | 10     |
| Contamination sheet .....     | 19     |
| Conversions .....             | 8      |
| Customer service .....        | 19     |

### D

|                       |    |
|-----------------------|----|
| Decommissioning ..... | 20 |
| Disassembly .....     | 20 |
| Disposal .....        | 20 |

### F

|                       |    |
|-----------------------|----|
| Flat gasket .....     | 10 |
| Flow measurement cell |    |
| Assemble .....        | 14 |
| Decommission .....    | 20 |
| Disassemble .....     | 20 |
| Flushing              |    |
| Connect .....         | 17 |
| Function .....        | 11 |

### G

|                     |    |
|---------------------|----|
| Goods receipt ..... | 12 |
|---------------------|----|

### Grounding

|               |    |
|---------------|----|
| Connect ..... | 17 |
|---------------|----|

### H

|                      |   |
|----------------------|---|
| Hazardous area ..... | 8 |
|----------------------|---|

### I

|                      |    |
|----------------------|----|
| Identification ..... | 13 |
| Intended use .....   | 7  |

### M

|                   |    |
|-------------------|----|
| Maintenance ..... | 18 |
|-------------------|----|

### N

|                        |    |
|------------------------|----|
| Nominal diameter ..... | 13 |
| Notices                |    |
| Illustration .....     | 6  |

### O

|                        |    |
|------------------------|----|
| Operating manual ..... | 5  |
| Operation .....        | 17 |
| Optical fiber .....    | 10 |
| Notices .....          | 16 |
| Optical holder .....   | 10 |

### P

|                                     |    |
|-------------------------------------|----|
| Personnel .....                     | 8  |
| Pressure level .....                | 13 |
| Protective adapter .....            | 10 |
| Protective adapter connection ..... | 10 |
| Protective equipment .....          | 9  |

### R

|                |    |
|----------------|----|
| Repair .....   | 19 |
| Return .....   | 19 |
| RFID tag ..... | 10 |

### S

|                         |      |
|-------------------------|------|
| Safety .....            | 7, 9 |
| Scope of delivery ..... | 13   |
| Screw connection .....  | 10   |

|                                       |    |
|---------------------------------------|----|
| Serial number                         |    |
| Flow measurement cell .....           | 13 |
| Optical fiber.....                    | 13 |
| Set-up .....                          | 10 |
| Spare parts .....                     | 19 |
| Specialist personnel. Siehe Personnel |    |
| Storage .....                         | 13 |

**T**

|                                |    |
|--------------------------------|----|
| Temperature sensor             |    |
| Assemble.....                  | 17 |
| Temperature sensor thread..... | 10 |
| Transport .....                | 12 |

**U**

|                |    |
|----------------|----|
| Unpacking..... | 12 |
|----------------|----|

**W**

|                    |   |
|--------------------|---|
| Warnings           |   |
| Illustration ..... | 6 |



**PLS-TEC**

PLS Prozess- Labor- und Sensortechnik GmbH  
Mittelstraße 23  
07745 Jena  
Germany

Phone +49 3641 – 47 92 80  
Fax +49 3641 – 47 92 81  
[info@pls-tec.com](mailto:info@pls-tec.com)  
[www.pls-tec.com](http://www.pls-tec.com)